

ESPRIT

**CRIOCABIN**  
TASTE PRESERVATION

▶ PRÊT À MANGER, FAST FOOD,  
FRESH FOOD

Gamma completa di banchi standard  
per soddisfare i nuovi approcci  
e tendenze della ristorazione veloce.

▶ PRÊT À MANGER, FAST FOOD,  
FRESH FOOD

Complete range of standard cabinets  
to satisfy new approaches and trends  
of fast-food sector.

▶ PRÊT À MANGER, FAST FOOD,  
FRESH FOOD

Gamme complète de vitrine standard  
pour satisfaire les nouvelles approches et  
tendances du domaine du prêt-à-manger.

▶ PRÊT À MANGER, FAST FOOD,  
FRESH FOOD

Vollständige Palette von Standardvitrinen  
zur Befriedigung der neuen Methoden  
und Tendenzen des Schnelllebensbereichs.





SPECIAL DESIGN CRIOCABIN STUDIO



Undergrowth













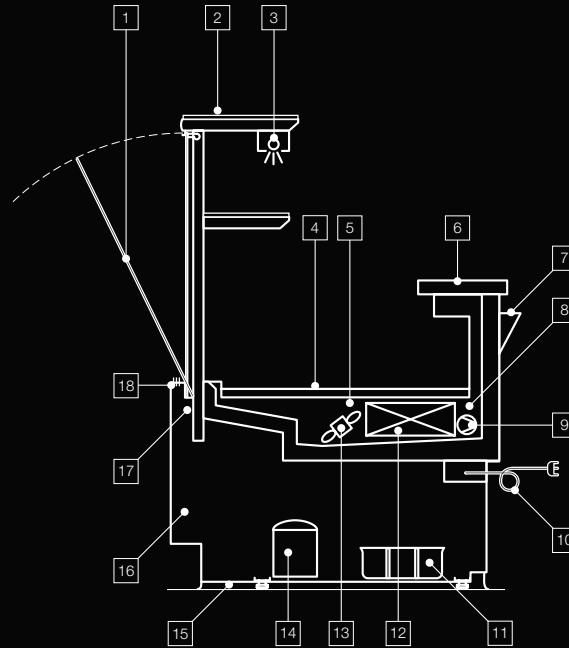

#### CARATTERISTICHE DEL MOBILE

1. Vetrina quadra con vetri apribili a compasso.
2. Piano d'appoggio superiore fisso in vetro.
3. Illuminazione: tubo fluorescente con luce Osram Warm White 830. (p)
4. Piano d'esposizione in acciaio inox AISI 304.
5. Interno del mobile in acciaio inox AISI 304.
6. Piano di lavoro in acciaio inox AISI 304 antigraffio.
7. Portacarta.
8. Sbrinamento ventilato con arresto del compressore.
9. Valvola termostatica a refrigerazione R404a. (p)
10. Quadro comandi elettronico.
11. Vasca per raccolta condensa.
12. Evaporatore con verniciatura anticorrosione.
13. Refrigerazione ventilata con potenziometro per regolazione della portata.
14. Gruppo frigorifero.
15. Zoccolo parapolvere su tutto il perimetro del banco.
16. Frontale personalizzabile - vedi tabella colori. (p)
17. Canalizzabile.
18. Ventilazione frontale antiappannante.

#### CABINET FEATURE

1. Straight glass structure with downwards glasses.
2. Fixed glass top surface.
3. Lighting: fluorescent tube with Osram Warm White 830 light. (p)
4. AISI 304 stainless steel display surface.
5. AISI 304 stainless-steel unit interior.
6. Working board in stainless steel scratchproof.
7. Paper-holder.
8. Ventilated defrosting with compressor block.
9. R404a thermostatic refrigeration valve. (p)
10. Electronic panel.
11. Condensing water collection tank.
12. Evaporator with anti-corrosion painting.
13. Ventilated refrigeration with potentiometer to adjust air flow rate.
14. Refrigeration unit.
15. Perimetrical bumper skirting.
16. Customizable front panel - see colour chart. (p)
17. Multiplexable.
18. Anti-fogging front ventilation.

#### CARACTERISTIQUES DE LA VITRINE

1. Éclairage vitrine équipée de protection lampes.
2. Plan d'appui supérieur fixe en verre.
3. Eclairage: tube fluorescent avec lumière Osram Warm White 830. (p)
4. Plan d'exposition en acier AISI 304.
5. Intérieur de la vitrine en acier inox AISI 304.
6. Tablette de travail en acier inox anti-rayure.
7. Porte-papier.
8. Dégivrage ventilé avec arrêt du compresseur.
9. Soupape thermostatique à réfrigération R404a. (p)
10. Panneau de contrôle électronique.
11. Bac de récolte de l'eau de condensation.
12. Évaporateur avec vernis anti-corrosion.
13. Réfrigération ventilée avec potentiomètre pour régulation du débit d'air.
14. Groupe frigorifique.
15. Plinthe de sol périmétral.
16. Façade personnalisable - voir tableau des couleurs. (p)
17. Canalisable.
18. Ventilation frontale anti buée.

#### EIGENSCHAFTEN DES MÖBELS

1. Gerade Vitrine mit Klappfenstern.
2. Fix montierte, obere Ablage aus Glas, Breite.
3. Beleuchtung: Leuchtrohr mit Lichtern Osram Warm White 830. (p)
4. Auslegefläche aus Edelstahl AISI 304.
5. Innenverarbeitung des Möbels aus rostfreiem Edelstahl AISI 304.
6. Arbeitsplatte aus kratzfestem Edelstahl 304.
7. Papiertaschen.
8. Abtauung mit automatischem Stopp des Kompressors.
9. Thermostatventil mit Kühlung R404a. (p)
10. Elektronische Steuerung.
11. Kondenswasser Sammelbehälter.
12. Verdunster mit korrosionsfester Lackierung.
13. Durchlüftete Kühlung mit Potentiometer für die Einstellung der Luftmenge.
14. Kühlaggregat.
15. Umlaufende Wischleiste.
16. Gestaltbare Frontpanel individuell - siehe Farbtabelle. (p)
17. Zusammenbaubar.
18. Antibeschlag Frontumlufkühlung.

## REFRIGERATO / REFRIGERATED / RÉFRIGÉRÉ / GEKÜHLT

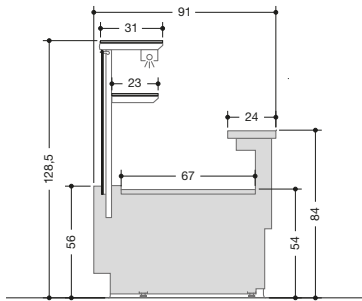

ESPRIT **ES200**  
Sandwich.  
Sandwich.  
Sandwich.  
Sandwichtheke.

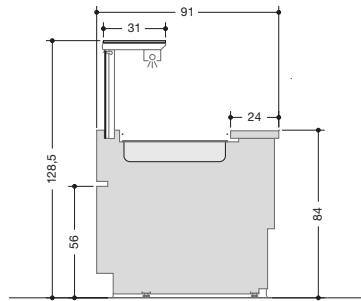

ESPRIT **ES210**  
Salad Bar.  
Salad Bar.  
Saladette.  
Salad Bar.

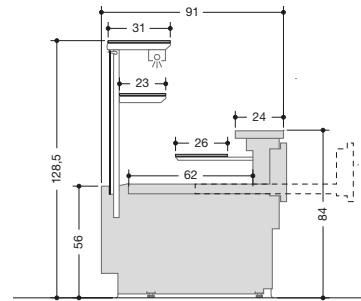

ESPRIT **ES300**  
Pasticceria.  
Pastry cabinet.  
Pâtisserie.  
Konditoreitheke.

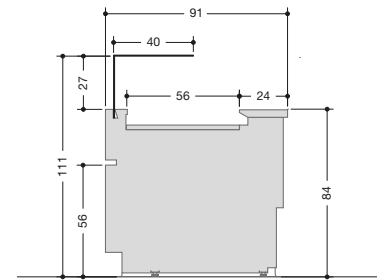

ESPRIT **ES350**  
Pasticceria.  
Pastry cabinet.  
Pâtisserie.  
Konditoreitheke.

## NON REFRIGERATO / NOT REFRIGERATED / NON RÉFRIGÉRÉ / OHNE KÜHLUNG

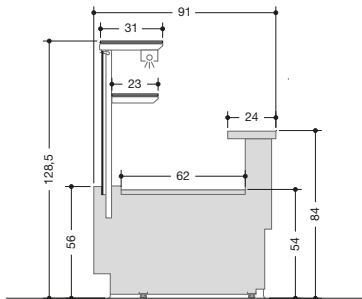

ESPRIT **ES310**  
Neutro.  
Neutral.  
Neutre.  
Neutral.

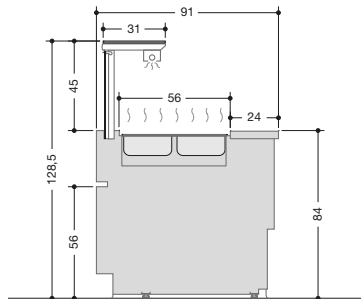

ESPRIT **ES400**  
Caldo bagno maria.  
Hot bain-marie.  
Chaud bain marie.  
Warm bain-marie.

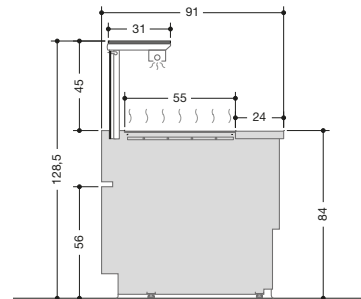

ESPRIT **ES410**  
Caldo piano riscaldato.  
Hot, heated plate.  
Chaud, surface réchauffée.  
Heiss, beheizter Oberfläche.

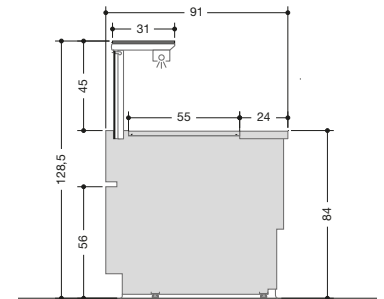

ESPRIT **ES600**  
Neutro.  
Neutral.  
Neutre.  
Neutral.

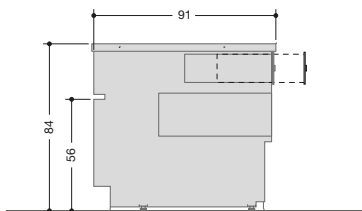

ESPRIT **SERVICE POINT**  
Service Point.

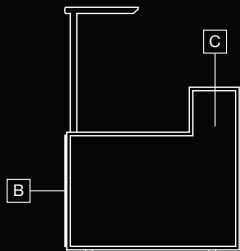

B	C
P01	P01★
P02	P02★
P23★	P23★
P24★	P24★
P25★	P25★
P26★	P26★
P27★	P27★
P28★	P28★
P29★	P29★
P30★	P30★
P31★	P31★
P32	P32★
P33★	P33★
P34★	P34★
P35★	P35★
P91	P91
P94	P94★
P95	P95★
I301★	I301★
I303★	I303★

P = Lamiera  
I = Acciaio inox  
★ Colore con sovrapprezzo

Si eseguono personalizzazioni e colori speciali su richiesta del cliente.

P = Plate  
I = Stainless steel  
★ Color at extra cost

We make custom and special colors on request.

P = Plaque  
I = Acier inox  
★ Supplément couleur

Nous faisons des couleurs personnalisées et sur demande spéciale.

P = Tafel  
I = Edelstahl  
★ Farbzuschlag

Wir machen individuelle und Sonderfarben auf Anfrage.

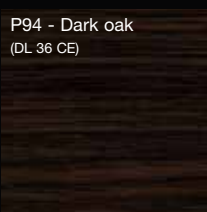
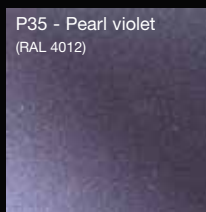
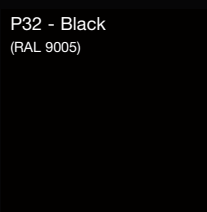
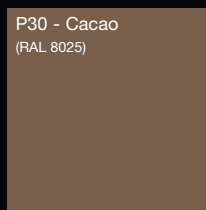
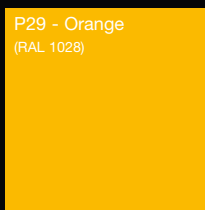
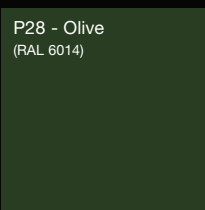
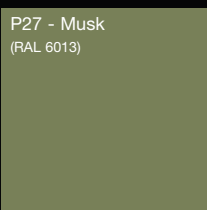
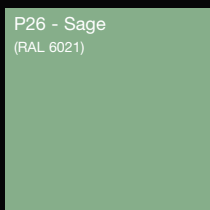
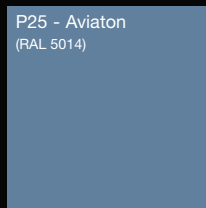
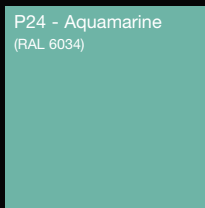
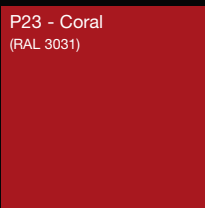
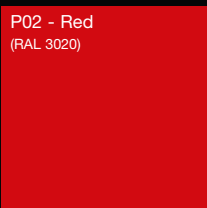

I colori RAL sono disponibili anche in versione opaca (matt).

A causa delle tecniche di riproduzione e di stampa, i colori possono essere diversi da come sono presentati. I colori RAL possono subire leggere variazioni cromatiche.

RAL colours are also available with a matt finish (matt).

Due to printing and reproduction techniques, the colours could be different to how they are represented. The RAL colours can suffer slight chromatic variations.

Les couleurs RAL sont aussi disponibles en version opaque (matt).

A cause des techniques de reproduction et d'imprimerie, les couleurs peuvent être différentes de comme ils sont présentées. Les couleurs RAL peuvent subir de légères variations chromatiques.

Die RAL-Farben sind auch in der matten Version lieferbar.

Die Farben können wegen Druck- und Reproduktionstechnik anders sein als die, die im Prospekt angegeben sind. RAL Farben können leichte farblichen Veränderungen erleide.

